

SLV3401T

30V P-Channel MOSFET

General Description

This Power MOSFET is produced using Msemitek's advanced TRENCH technology. This advanced technology has been especially tailored to minimize conduction loss, provide superior switching performance, and withstand high energy pulse in the avalanche and commutation mode.

Application

- PWM Application
- Load Switch
- Power Management

Features

- P-Channel: -30V -4.2A
 $R_{DS(on)Typ} = 44m\Omega @ V_{GS} = -4.5V$
 $R_{DS(on)Typ} = 54m\Omega @ V_{GS} = -2.5V$
- Very Low On-resistance $R_{DS(ON)}$
- Low C_{rss}
- Fast switching
- Improved dv/dt capability

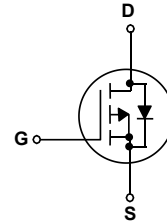
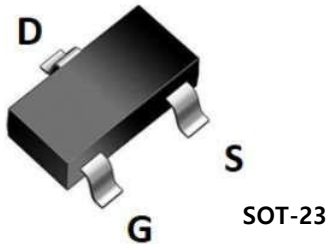

Absolute Maximum Ratings $T_C = 25^\circ\text{C}$ unless otherwise noted

Symbol	Parameter	SLV3401T	Units
V_{DSS}	Drain-Source Voltage	-30	V
I_D	Drain Current - Continuous ($T_C = 25^\circ\text{C}$)	-4.2	A
		-2.7	A
I_{DM}	Drain Current - Pulsed (Note 1)	-25	A
V_{GSS}	Gate-Source Voltage	± 20	V
P_D	Power Dissipation ($T_C = 25^\circ\text{C}$)	1.25	W
$R_{\theta JA}$	Thermal Resistance, Junction-to-Ambient	100	$^\circ\text{C/W}$
T_J, T_{STG}	Operating and Storage Temperature Range	-55 to +150	$^\circ\text{C}$
T_L	Maximum lead temperature for soldering purposes, 1/8" from case for 5 seconds	300	$^\circ\text{C}$

* Drain current limited by maximum junction temperature.

Package Marking

Part Number	Top Marking	Package	Packing Method	MOQ	QTY
SLV3401T	3401T	SOT-23	Tape & Reel	3000	180000

Electrical Characteristics

$T_C = 25^\circ\text{C}$ unless otherwise noted

Symbol	Parameter	Test Conditions	Min	Typ	Max	Units
--------	-----------	-----------------	-----	-----	-----	-------

Off Characteristics

BV_{DSS}	Drain-Source Breakdown Voltage	$V_{GS} = 0\text{ V}, I_D = -250\text{ }\mu\text{A}$	-30	--	--	V
I_{DSS}	Zero Gate Voltage Drain Current	$V_{DS} = -30\text{ V}, V_{GS} = 0\text{ V}$	--	--	-1	μA
		$V_{DS} = -24\text{ V}, T_C = 125^\circ\text{C}$	--	--	-10	μA
I_{GSSF}	Gate-Body Leakage Current, Forward	$V_{GS} = -10\text{ V}, V_{DS} = 0\text{ V}$	--	--	-100	nA
I_{GSSR}	Gate-Body Leakage Current, Reverse	$V_{GS} = 10\text{ V}, V_{DS} = 0\text{ V}$	--	--	100	nA

On Characteristics

$V_{GS(th)}$	Gate Threshold Voltage	$V_{DS} = V_{GS}, I_D = -250\text{ }\mu\text{A}$	-1.0	-1.6	-2.2	V
$R_{DS(on)}$	Static Drain-Source On-Resistance	$V_{GS} = -4.5\text{ V}, I_D = -4\text{ A}$	--	44	55	m Ω
		$V_{GS} = -2.5\text{ V}, I_D = -1\text{ A}$	-	54	68	

Dynamic Characteristics

C_{iss}	Input Capacitance	$V_{DS} = -15\text{ V}, V_{GS} = 0\text{ V},$ $f = 1.0\text{ MHz}$	--	692	-	pF
C_{oss}	Output Capacitance		--	69	-	pF
C_{riss}	Reverse Transfer Capacitance		--	55	-	pF

Switching Characteristics

$t_{d(on)}$	Turn-On Delay Time	$V_{GS} = -10\text{ V}, V_{DS} = -15\text{ V}, I_D = -4.2\text{ A},$ $R_G = 6\Omega$	--	8	--	ns
t_r	Turn-On Rise Time		--	30	--	ns
$t_{d(off)}$	Turn-Off Delay Time		--	20	--	ns
t_f	Turn-Off Fall Time		--	28	--	ns
Q_g	Total Gate Charge	$V_{DS} = -15\text{ V}, I_D = -4.2\text{ A},$ $V_{GS} = -4.5\text{ V}$	--	7.3	--	nC
Q_{gs}	Gate-Source Charge		--	0.8	--	nC
Q_{gd}	Gate-Drain Charge		--	1.2	--	nC

Drain-Source Diode Characteristics and Maximum Ratings

I_S	Maximum Continuous Drain-Source Diode Forward Current	--	--	-4.2	A
I_{SM}	Maximum Pulsed Drain-Source Diode Forward Current	--	--	-15	A
V_{SD}	Drain to Source Diode Forward Voltage, $V_{GS} = 0\text{ V}, I_{SD} = -3\text{ A}, T_J = 25^\circ\text{C}$	--	--	-1.2	V

Notes:

1. Repetitive Rating: Pulse Width Limited by Maximum Junction Temperature
2. Device mounted on FR-4 PCB, 1inch x 0.85inch x 0.062 inch
3. Pulse Test: Pulse Widths \leq 300 μ s, Duty Cycles \leq 0.5%

P- Channel Typical Characteristics

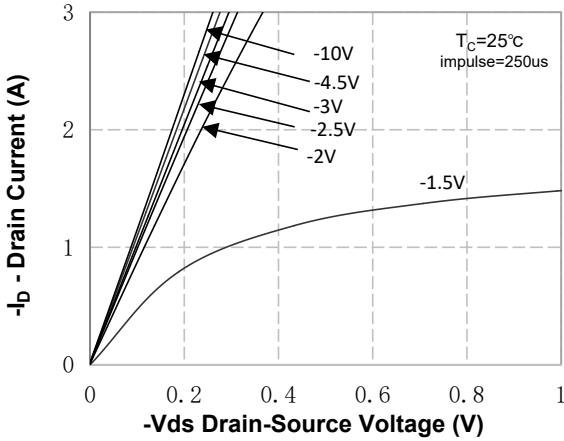

Figure 1. On-Region Characteristics

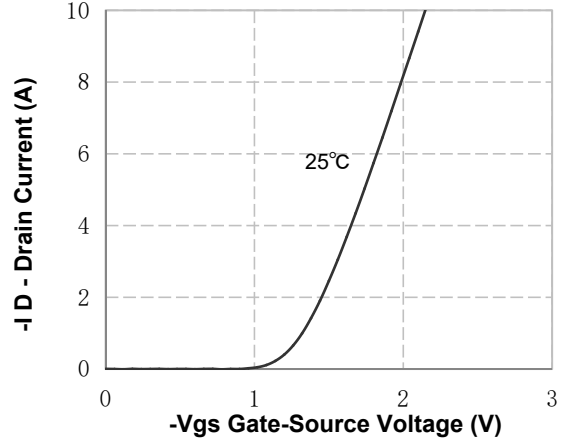

Figure 2. Transfer Characteristics

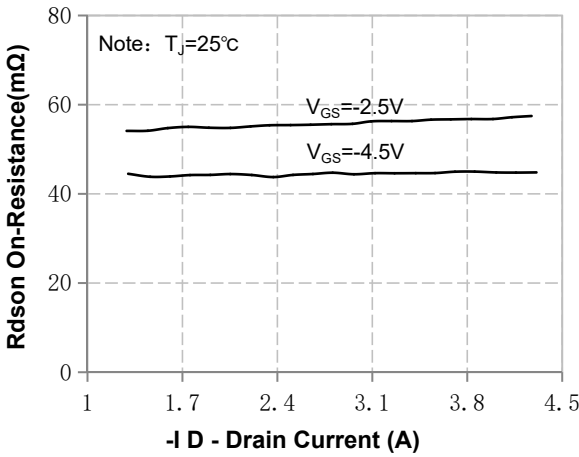

Figure 3. On-Resistance Variation vs Drain Current and Gate Voltage

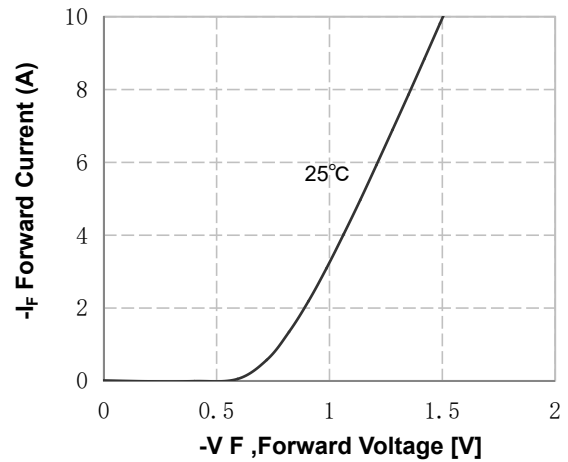

Figure 4. Body Diode Forward Voltage Variation with Source Current

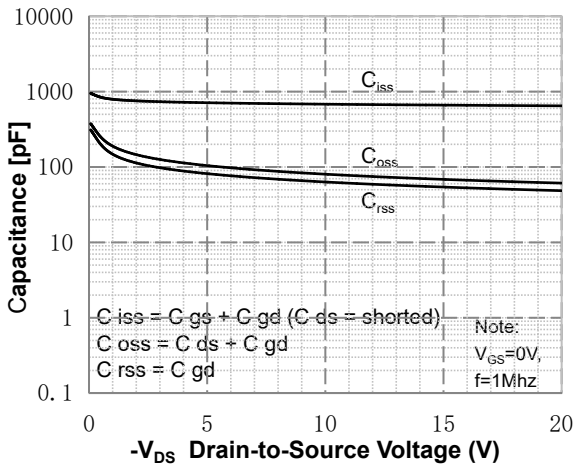

Figure 5. Capacitance Characteristics

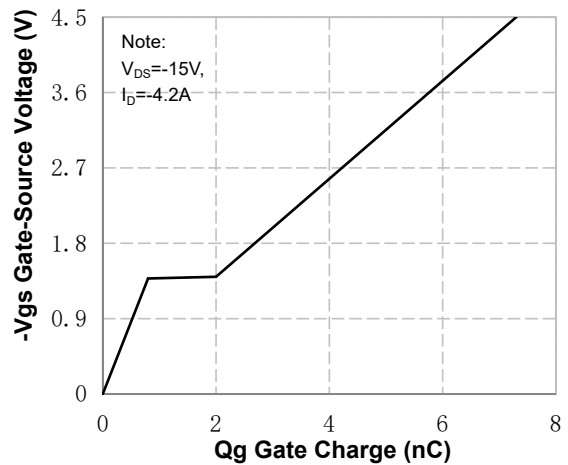

Figure 6. Gate Charge Characteristics

P- Channel Typical Characteristics (Continued)

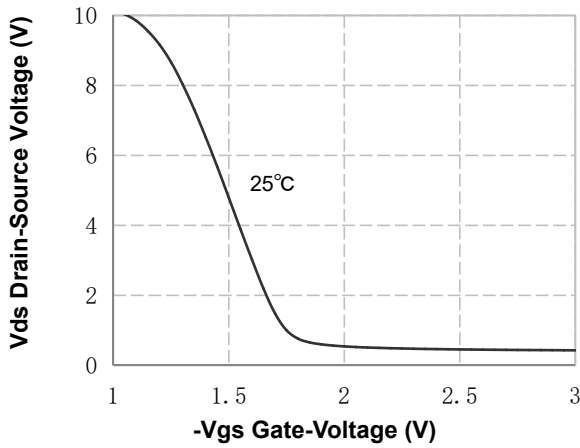

Figure 7. Vds Drain-Source Voltage vs Gate Voltage

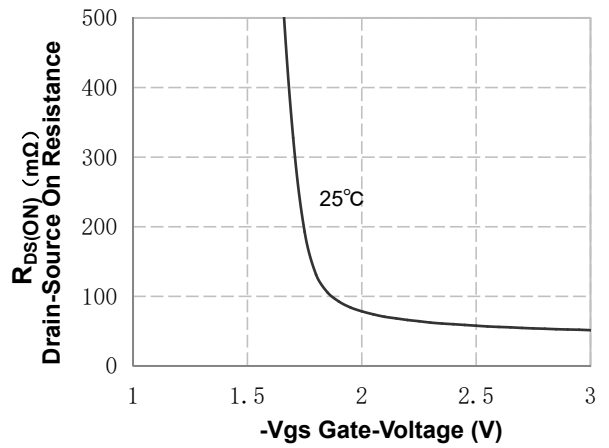

Figure 8. On-Resistance vs Gate Voltage

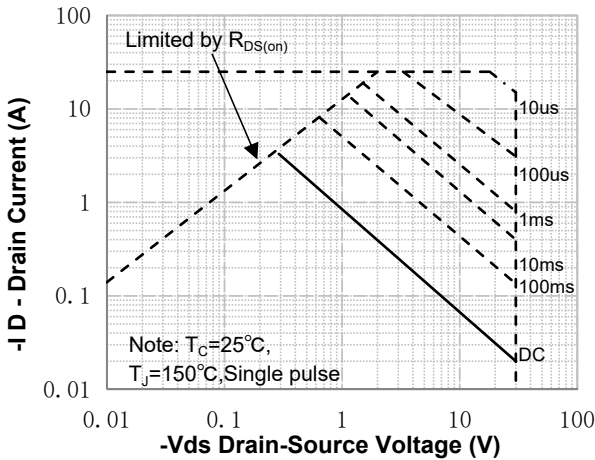

Figure 9. Maximum Safe Operating Area

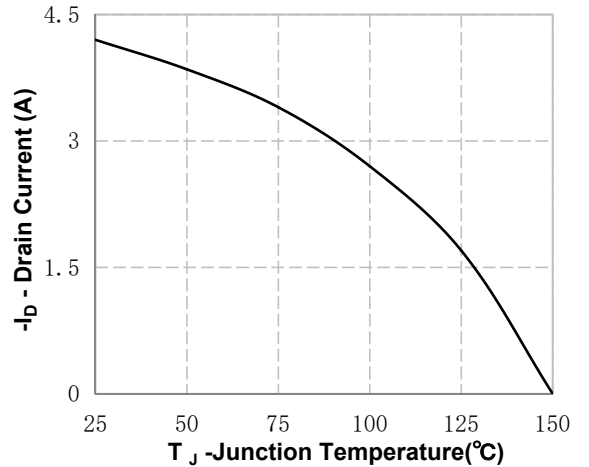

Figure 10. Maximum PContinuous Drain Current vs Temperature

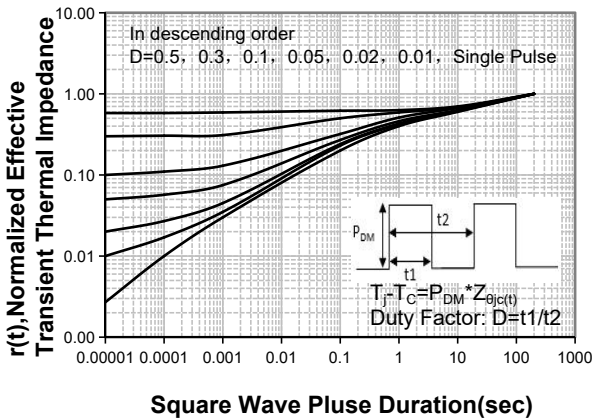
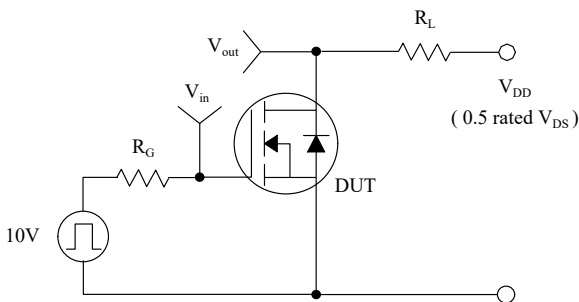

Figure 11. Transient Thermal Response Curve

Gate Charge Test Circuit & Waveform



Resistive Switching Test Circuit & Waveforms



Unclamped Inductive Switching Test Circuit & Waveforms

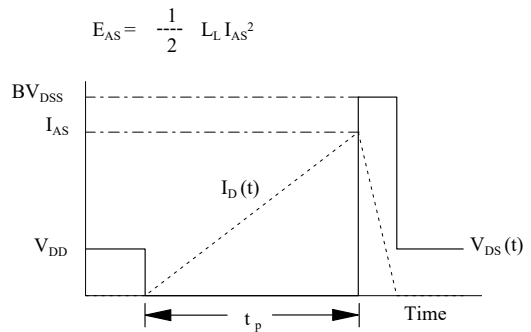

Peak Diode Recovery dv/dt Test Circuit & Waveforms



SOT-23 OUTLINE

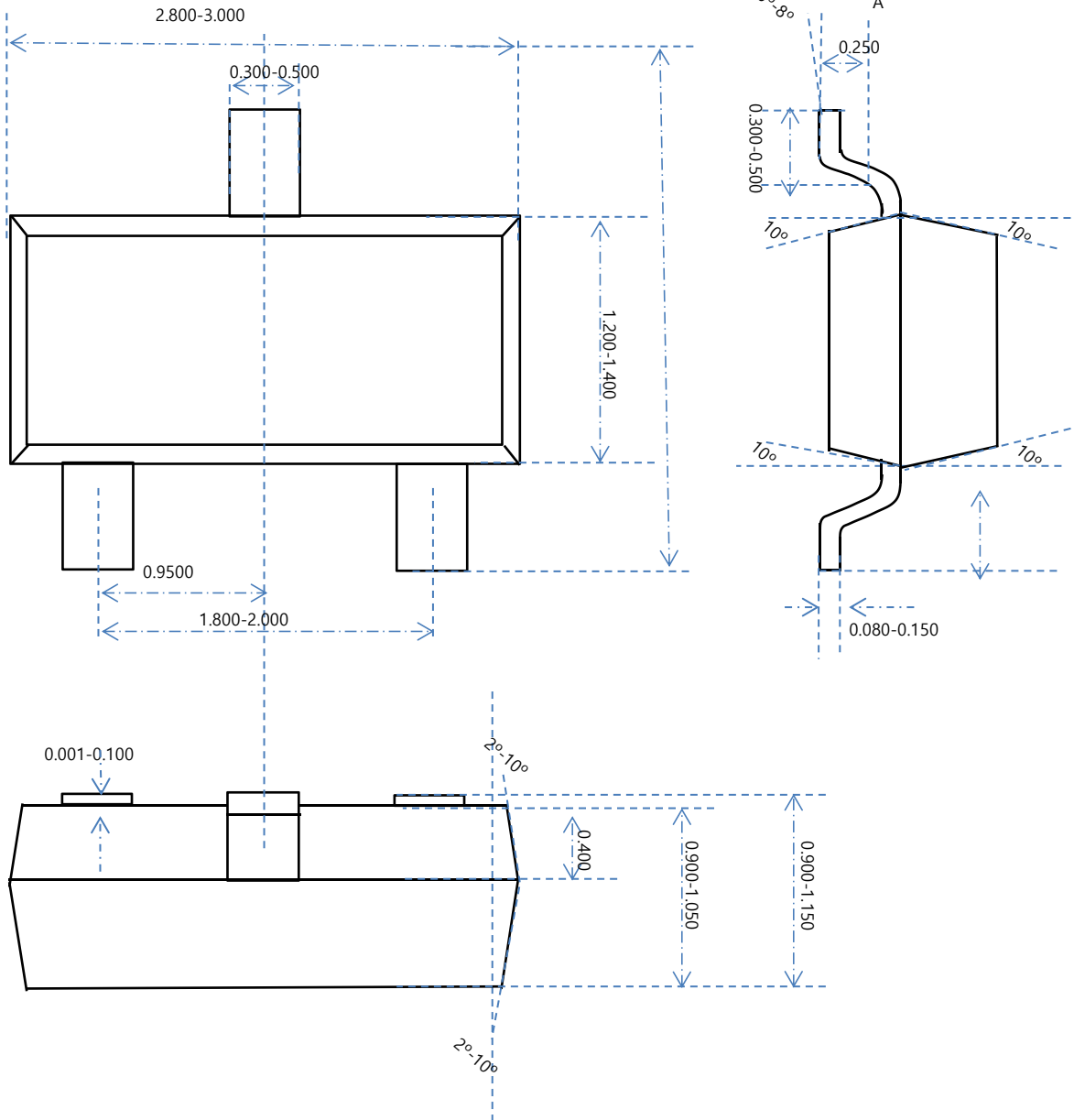

NOTE:

- 1The plastic package is not marked as smooth surfaceRa=0.1; Subglossy surfaceRa=0.8
- 2.Undeclared tolerance ± 0.25 , Unmarked fillet Rmax=0.25

Disclaimer

The content specified herein is for the purpose of introducing Msemitek's products (here in after "Products"). The information given in this document shall in no event be regarded as a guarantee of conditions or characteristics. Examples of application circuits, circuit constants and any other information contained herein illustrate the standard usage and operations of the Products. The peripheral conditions must be taken into account when designing circuits for mass production.

Msemitek does not assume any liability for infringement of patents, copyrights, or other intellectual property rights of third parties by or arising from the use of the Products or technical information described in this document.

The products are not designed or manufactured to be used with any equipment, device or system which requires an extremely high level of reliability the failure or malfunction of which may result in a direct threat to human life or create a risk of human injury (such as a medical instrument, transportation equipment, aerospace machinery, nuclear-reactor controller, fuel-controller or other safety device). Msemitek shall bear no responsibility in any way for use of any of the Products for the above special purposes.

Although, Msemitek endeavors to improve the quality and reliability of its products, semiconductor products have specific characteristics such as the occurrence of failure at a certain rate and malfunctions under certain use conditions. Please be sure to implement safety measures to guard them against the possibility of physical injury, and injury or damage caused by fire in the event of the failure of a Msemitek's product.

The content specified herein is subject to change for improvement without notice. When using a Msemitek's product, be sure to obtain the latest specifications.