

MS2H10120G1

1200V Silicon Carbide Diode

Features

- 1200-Volt Schottky Rectifier
- Shorter recovery time
- High-speed switching possible
- High-Frequency Operation
- Temperature-Independent Switching Behavior
- Extremely Fast Switching
- Positive Temperature Coefficient on VF

Benefits

- Higher safety margin against overvoltage
- Improved efficiency all load conditions
- Increased efficiency compared to Silicon Diode alternatives
- Reduction of Heat Sink Requirements
- Parallel Devices Without Thermal Runaway
- Essentially No Switching Losses

Applications

- Switch Mode Power Supplies
- Power Factor Correction
- Motor Drives
- HID Lighting

Package



Type : TO-247-3Lead

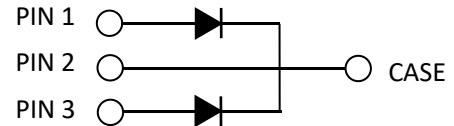

Absolute Maximum Ratings

$T_c = 25^\circ\text{C}$ unless otherwise noted

| Symbol | Parameter | MS2H10120G1 | Units | |
|-----------|---|---------------------------|------------------|---|
| VRRM | Repetitive Peak Reverse Voltage | 1200 | V | |
| VRSM | Surge Peak Reverse Voltage | 1200 | V | |
| VDC | DC Blocking Voltage | 1200 | V | |
| IF | Continuous Forward Current @ $T_c=150^\circ\text{C}$ | 10 | A | |
| | Continuous Forward Current @ $T_c=25^\circ\text{C}$ | 40.8 | | |
| IFRM | Repetitive Peak Forward Surge Current @ $T_c=25^\circ\text{C}$, $t_P = 10$ ms, Half Sine Wave | 30 | A | |
| IFSM | Non-Repetitive Peak Forward Surge Current @ $T_c=25^\circ\text{C}$, $t_P = 10$ ms, Half Sine Wave | 60 | A | |
| IF,Max | Non-Repetitive Peak Forward Surge Current ;@ $T_c=25^\circ\text{C}$, $t_P= 10$ μs , Pulse | 400 | A | |
| Ptot | Power Dissipation (Per Leg/Device) | @ $T_c=25^\circ\text{C}$ | 130 | W |
| | | @ $T_c=110^\circ\text{C}$ | 56 | |
| TJ , Tstg | Operating Junction and Storage Temperature | -55 to +175 | $^\circ\text{C}$ | |

Electrical Characteristics

$T_C = 25^\circ \text{C}$ unless otherwise noted

| Symbol | Test Conditions | Test Conditions | Min | Typ | Max | Unit |
|--------|---------------------------|--|-----|-----------------|------------|------|
| VF | Forward Voltage(Per Lag) | IF=5A, TC=25° C IF=5A, TC=175° C | - | 1.5 2.0 | 1.8 3.0 | V |
| IR | Reverse Current | VR=1200V, TC=25° C VR=1200V, TC=175° C | - | 2 50 | 10 100 | μA |
| QC | Total Capacitive Charge | VR =800V, TJ = 25° C $Q_c = \int_0^{t_r} C(V) dv$ | - | 24 | - | nC |
| C | Total Capacitance | VR =0V, TJ = 25° C, f=1MHz VR =400V, TJ = 25° C, f=1MHz VR =800V, TJ = 25° C, f=1MHz | - | 340 22 18 | - | pF |
| Ec | Capacitance Stored Energy | VR=800V | - | 12 | - | μJ |

Thermal Characteristics

| Symbol | Parameter | Typ | Unit |
|--------|--|------|------|
| RθJC | Thermal Resistance from Junction to Case | 1.15 | °C/W |

Typical Characteristics

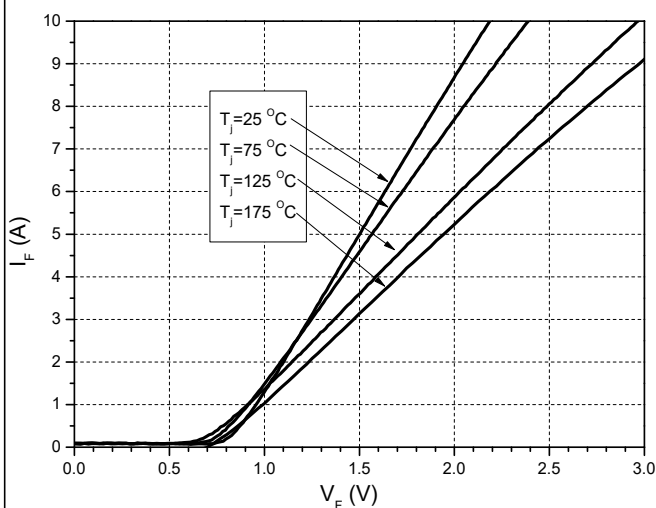

Figure 1. Forward Characteristics

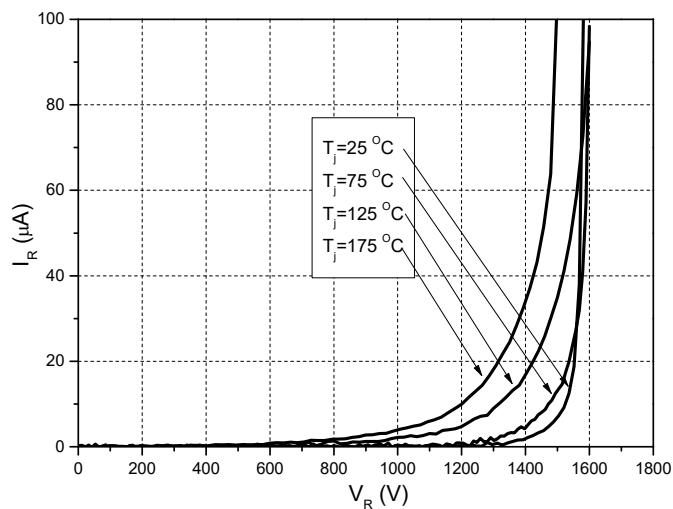

Figure 2. Reverse Characteristics

Typical Characteristics

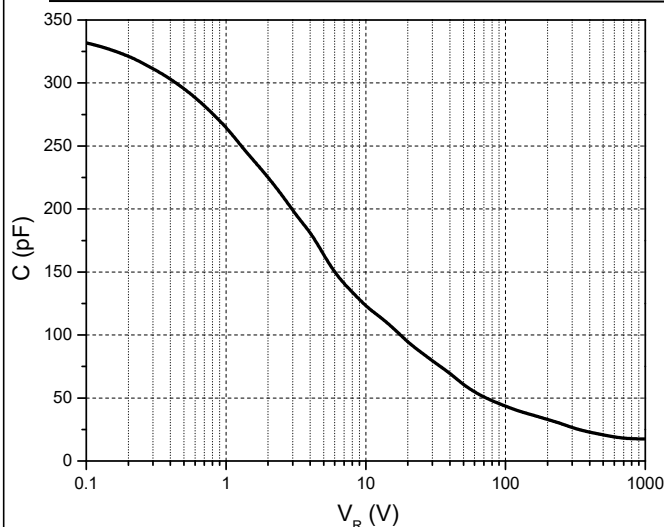

Figure 3. Capacitance vs. Reverse Voltage

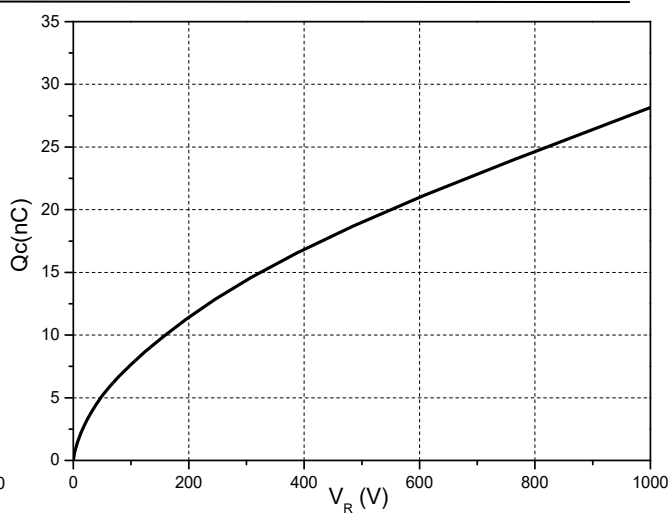

Figure 4. Total Capacitance Charge vs. Reverse Voltage

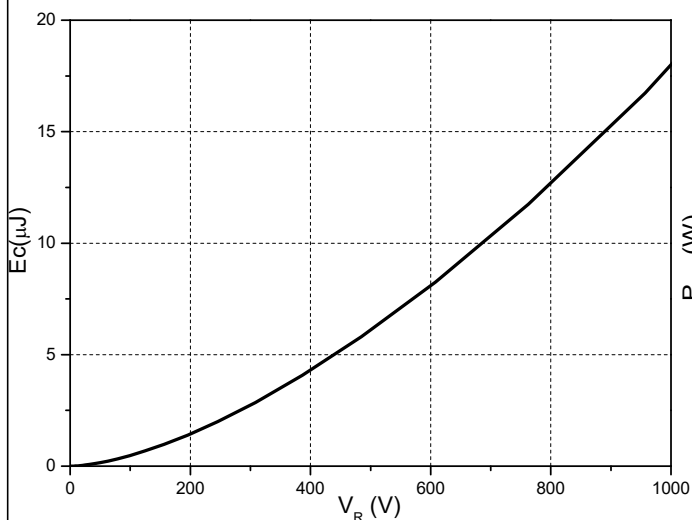

Figure 5. Capacitance Stored Energy

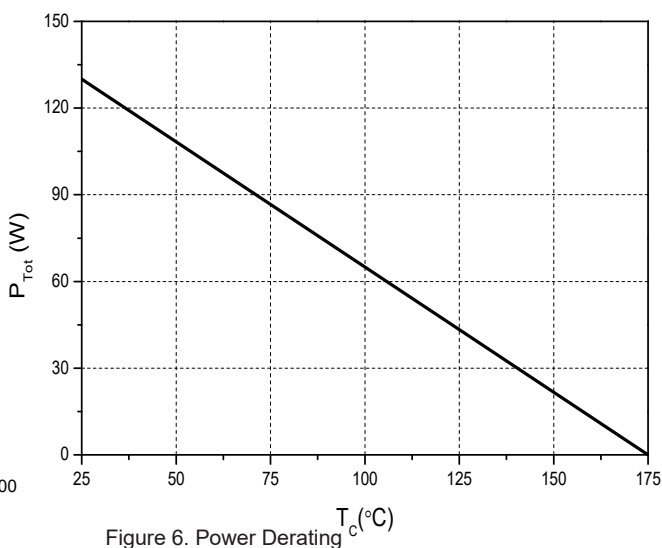

Figure 6. Power Derating $T_c (^{\circ}C)$

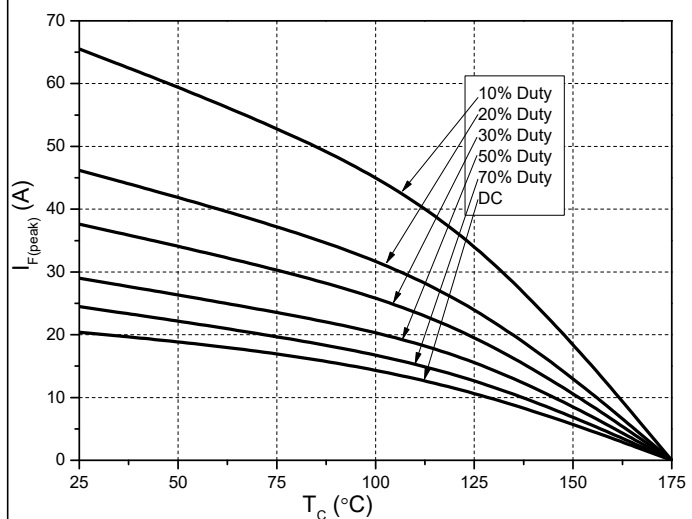

Figure 7. Current Derating

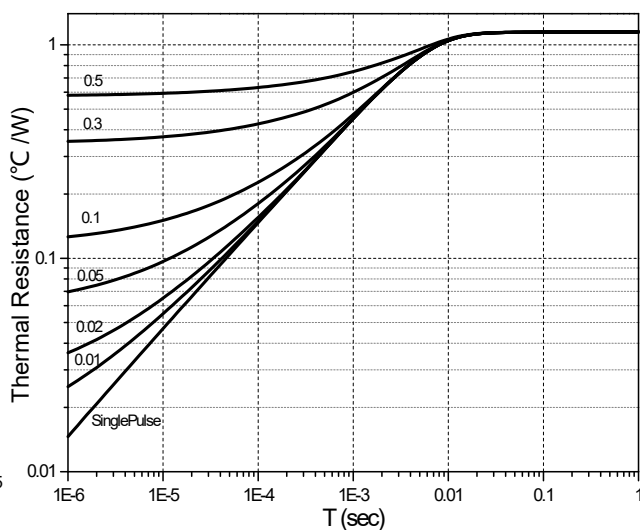
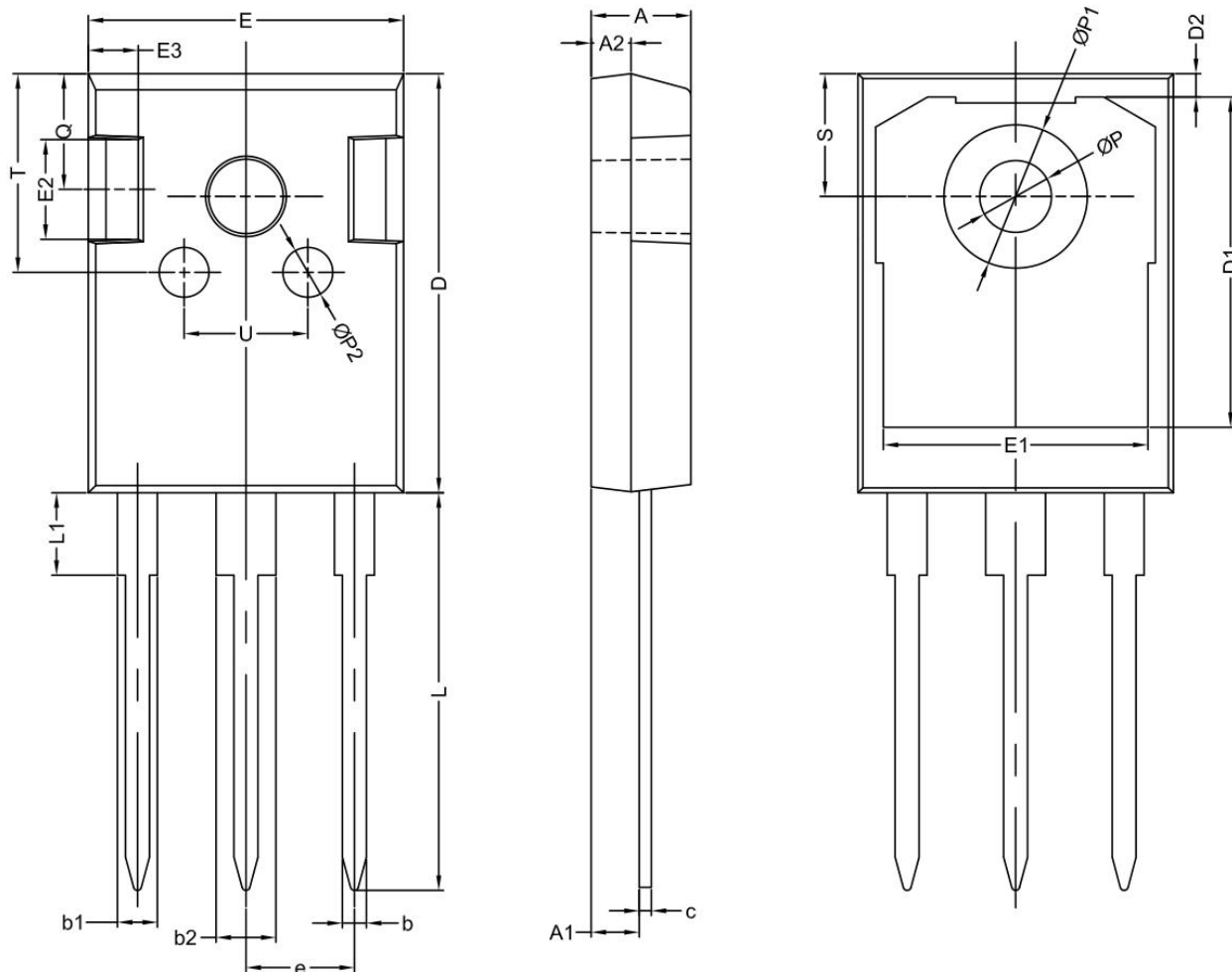

Figure 8. Transient Thermal Impedance

TO-247 OUTLINE



| SYMBOL | Mechanical Dimensions/mm | | | SYMBOL | Mechanical Dimensions/mm | | | SYMBOL | Mechanical Dimensions/mm | | |
|--------|--------------------------|------|------|--------|--------------------------|-------|-------|--------|--------------------------|------|------|
| | MIN | NOM | MAX | | | | | | MIN | NOM | MAX |
| A | 4.80 | 5.00 | 5.20 | D | 20.80 | 21.00 | 21.20 | L1 | - | 4.13 | - |
| A1 | 2.21 | 2.41 | 2.61 | D1 | - | 16.55 | - | Ø P | 3.5 | 3.6 | 3.7 |
| A2 | 1.90 | 2.00 | 2.10 | E | 15.60 | 15.80 | 16.0 | Ø P1 | - | - | 7.40 |
| b | 1.10 | 1.20 | 1.35 | E1 | | 13.3 | | Ø P2 | - | 2.50 | - |
| b1 | - | 2.00 | - | E2 | | 5.0 | | Q | - | 5.8 | - |
| b2 | - | 3.00 | - | e | | 5.44 | | S | 6.05 | 6.15 | 6.25 |
| c | 0.55 | 0.60 | 0.75 | L | 19.42 | 19.92 | 20.42 | T | - | 10.0 | - |

NOTE:

1The plastic package is not marked as smooth surfaceRa=0.1;Subglossy surfaceRa=0.8

2.Undeclared tolerance ± 0.25 , Unmarked filletRmax=0.25