

# SLD60N02T

## 20V N -Channel MOSFET

### General Description

This Power MOSFET is produced using Maple semi's advanced planar stripeTRENCH technology. This advanced technology has been especially tailored to minimize conduction loss, provide superior switching performance, and withstand high energy pulse in the avalanche and commutation mode.

### Application

- PWM Application
- Load Switch
- Power Management

### Features

- N-Channel:20V 60A
  - $R_{DS(on)Typ} = 4.5m\Omega @ V_{GS} = 4.5V$
  - $R_{DS(on)Typ} = 6.5m\Omega @ V_{GS} = 2.5V$
- Very Low On-resistance RDS(ON)
- LowCrss
- Fast switching
- 100% avalanche tested
- Improved dv/dt capability

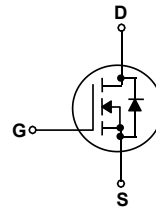
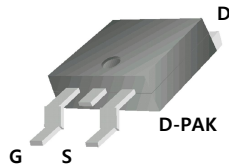

### Absolute Maximum Ratings $T_C = 25^\circ\text{C}$ unless otherwise noted

Symbol	Parameter	SLD60N02T	Units
$V_{DSS}$	Drain-Source Voltage	20	V
$I_D$	Drain Current - Continuous ( $T_C = 25^\circ\text{C}$ ) - Continuous ( $T_C = 100^\circ\text{C}$ )	60	A
		39	A
$I_{DM}$	Drain Current - Pulsed (Note 1)	240	A
$V_{GSS}$	Gate-Source Voltage	$\pm 12$	V
$E_{AS}$	Single Pulsed Avalanche Energy	47.6	mJ
$P_D$	Power Dissipation ( $T_C = 25^\circ\text{C}$ )	37	W
$R_{\theta JC}$	Thermal Resistance, Junction to Case	4	W/ $^\circ\text{C}$
$T_J, T_{STG}$	Operating and Storage Temperature Range	-55 to +150	$^\circ\text{C}$
$T_L$	Maximum lead temperature for soldering purposes, 1/8" from case for 5 seconds	300	$^\circ\text{C}$

\* Drain current limited by maximum junction temperature.

**Electrical Characteristics** $T_C = 25^\circ\text{C}$  unless otherwise noted

Symbol	Parameter	Test Conditions	Min	Typ	Max	Units
--------	-----------	-----------------	-----	-----	-----	-------

**Off Characteristics**

$BV_{DSS}$	Drain-Source Breakdown Voltage	$V_{GS} = 0\text{ V}, I_D = 250\text{ }\mu\text{A}$	20	--	--	V
$I_{DSS}$	Zero Gate Voltage Drain Current	$V_{DS} = 20\text{ V}, V_{GS} = 0\text{ V}$	--	--	1	$\mu\text{A}$
		$V_{DS} = 16\text{ V}, T_C = 125^\circ\text{C}$	--	--	10	$\mu\text{A}$
$I_{GSSF}$	Gate-Body Leakage Current, Forward	$V_{GS} = 20\text{ V}, V_{DS} = 0\text{ V}$	--	--	100	nA
$I_{GSSR}$	Gate-Body Leakage Current, Reverse	$V_{GS} = -20\text{ V}, V_{DS} = 0\text{ V}$	--	--	-100	nA

**On Characteristics**

$V_{GS(th)}$	Gate Threshold Voltage	$V_{DS} = V_{GS}, I_D = 250\text{ }\mu\text{A}$	0.4	0.65	1.0	V
$R_{DS(on)}$	Static Drain-Source On-Resistance	$V_{GS} = 4.5\text{ V}, I_D = 25\text{ A}$	--	4.5	6.5	$\text{m}\Omega$
		$V_{GS} = 2.5\text{ V}, I_D = 15\text{ A}$	-	6.5	10	

**Dynamic Characteristics**

$C_{iss}$	Input Capacitance	$V_{DS} = 10\text{ V}, V_{GS} = 0\text{ V},$ $f = 1.0\text{ MHz}$	--	1800	-	$\text{pF}$
$C_{oss}$	Output Capacitance		--	290	-	$\text{pF}$
$C_{riss}$	Reverse Transfer Capacitance		--	275	-	$\text{pF}$

**Switching Characteristics**

$t_{d(on)}$	Turn-On Delay Time	$V_{GS} = 4.5\text{ V}, V_{DS} = 10\text{ V},$ $R_G = 3\text{ }\Omega, I_D = 25\text{ A}$	--	15	--	ns
$t_r$	Turn-On Rise Time		--	35	--	ns
$t_{d(off)}$	Turn-Off Delay Time		--	52	--	ns
$t_f$	Turn-Off Fall Time		--	21	--	ns
$Q_g$	Total Gate Charge		$V_{DS} = 10\text{ V}, I_D = 25\text{ A},$ $V_{GS} = 4.5\text{ V}$	--	23	--
$Q_{gs}$	Gate-Source Charge	--		4.5	--	nC
$Q_{gd}$	Gate-Drain Charge	--		7.5	--	nC

**Drain-Source Diode Characteristics and Maximum Ratings**

$I_S$	Maximum Continuous Drain-Source Diode Forward Current	--	--	60	A
$I_{SM}$	Maximum Pulsed Drain-Source Diode Forward Current	--	--	240	A
$V_{SD}$	Drain to Source Diode Forward Voltage, $V_{GS} = 0\text{ V}, I_{SD} = 30\text{ A}, T_J = 25^\circ\text{C}$	--	--	1.2	V

**Notes:**

1. Repetitive Rating: Pulse Width Limited by Maximum Junction Temperature
2. EAS condition:  $T_J = 25^\circ\text{C}, V_{DD} = 10\text{ V}, V_G = 4.5\text{ V}, R_G = 25\Omega, L = 0.5\text{ mH}, I_{AS} = 14\text{ A}$
3. Pulse Test: Pulse Width  $\leq 300\mu\text{s}$ , Duty Cycle  $\leq 0.5\%$

### N- Channel Typical Characteristics

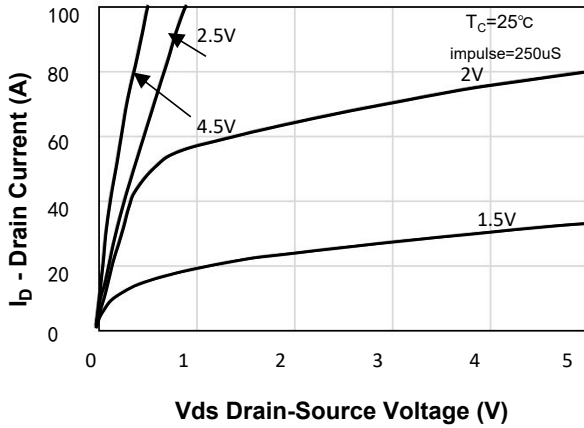

Figure 1. On-Region Characteristics

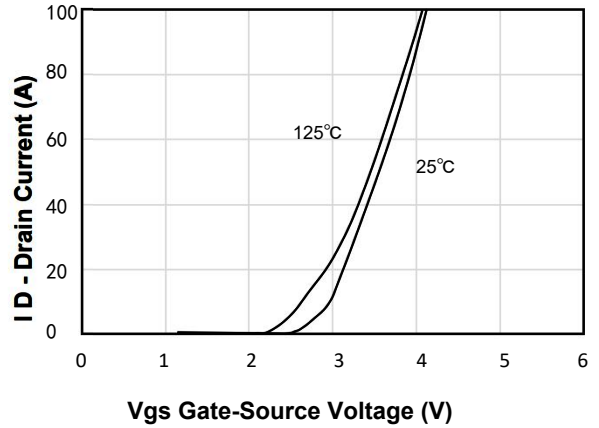

Figure 2. Transfer Characteristics

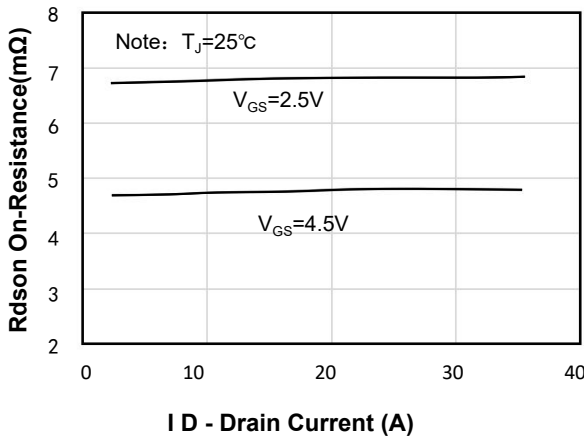

Figure 3. On-Resistance Variation vs Drain Current and Gate Voltage

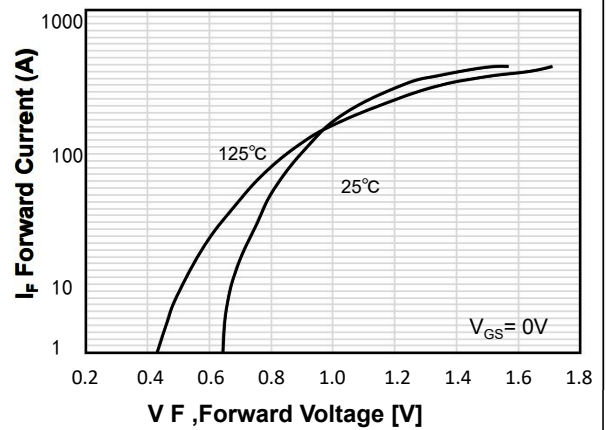

Figure 4. Body Diode Forward Voltage Variation with Source Current and Temperature

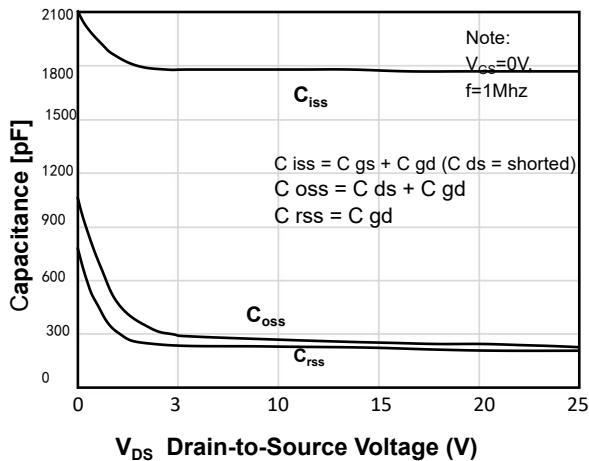

Figure 5. Capacitance Characteristics

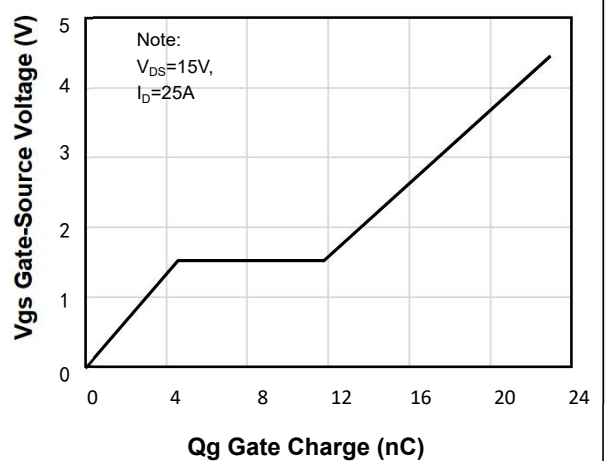

Figure 6. Gate Charge Characteristics

N- Channel Typical Characteristics (Continued)

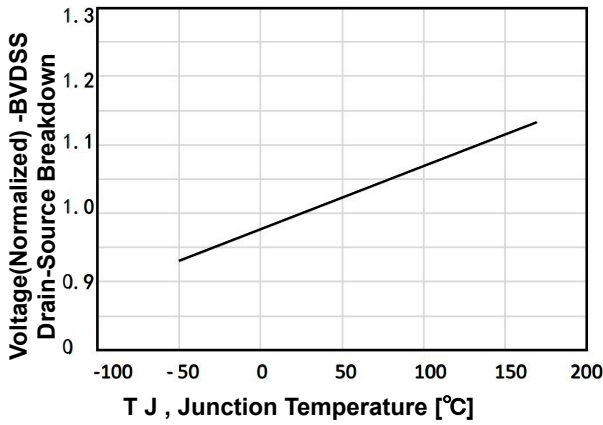

Figure 7. Breakdown Voltage Variation vs Temperature

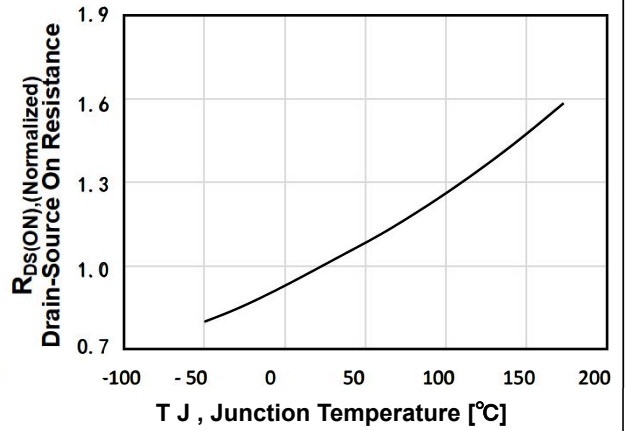

Figure 8. On-Resistance Variation vs Temperature

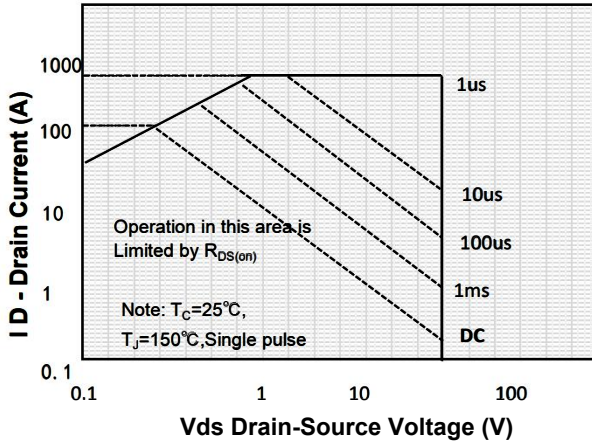

Figure 9. Maximum Safe Operating Area

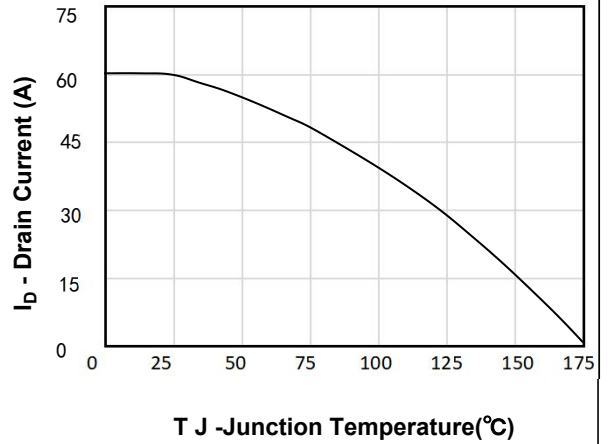

Figure 10. Maximum PContinuous Drain Current vs Case Temperature

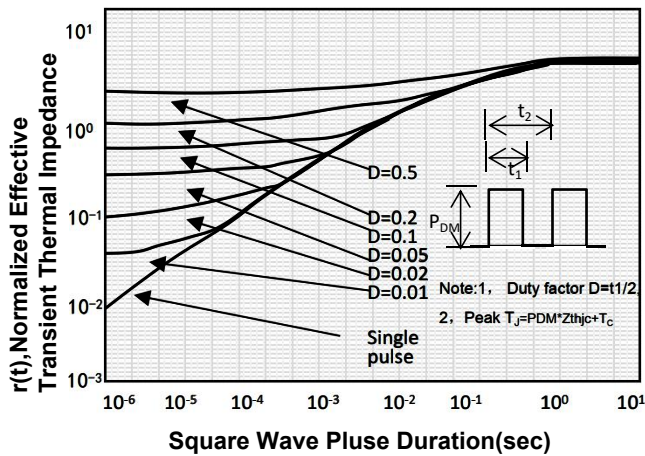
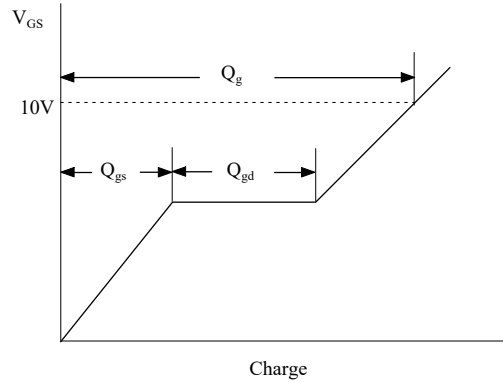
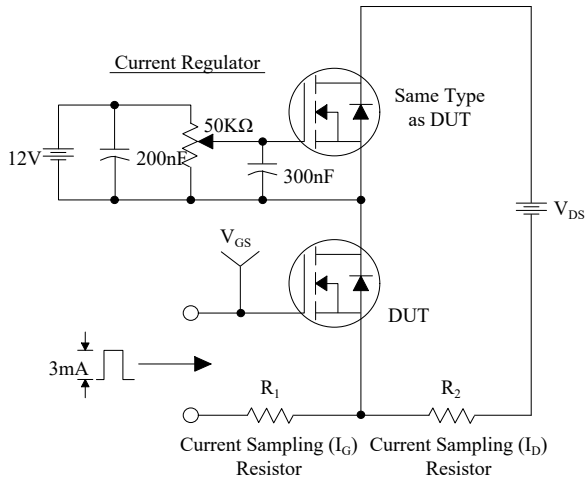
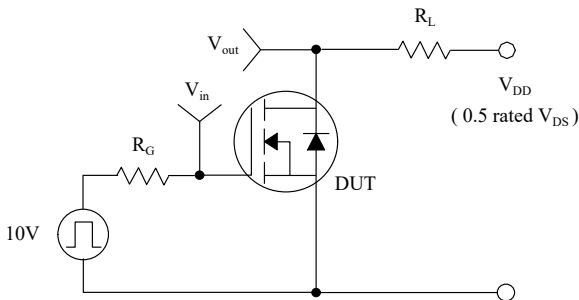

Figure 11. Transient Thermal Response Curve

### Gate Charge Test Circuit & Waveform



### Resistive Switching Test Circuit & Waveforms



### Unclamped Inductive Switching Test Circuit & Waveforms



$$E_{AS} = \frac{1}{2} L_L I_{AS}^2$$

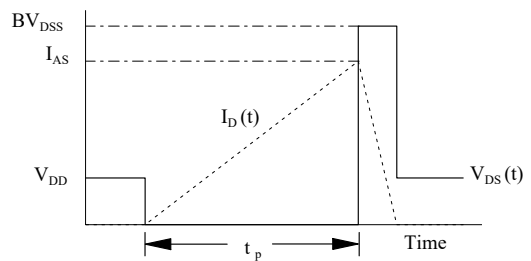

# Peak Diode Recovery dv/dt Test Circuit & Waveforms

